

MECHANICAL DATA

**GOLD METALLISED  
MULTI-PURPOSE SILICON  
DMOS RF FET  
120W – 28V – 175MHz  
SINGLE ENDED**

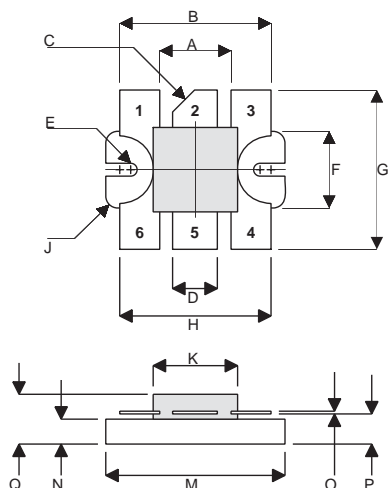

DV

PIN 1	SOURCE	PIN 2	DRAIN
PIN 3	SOURCE	PIN 4	SOURCE
PIN 5	GATE	PIN 6	SOURCE

DIM	mm	Tol.	Inches	Tol.
A	9.09	0.13	0.358	0.005
B	19.3	0.13	0.760	0.005
C	45°	5°	45°	5°
D	5.71	0.13	0.225	0.005
E	1.65R	0.13	0.065R	0.005
F	10.16	0.13	0.400	0.005
G	20.32	0.25	0.800	0.010
H	19.30	0.13	0.760	0.005
J	1.52R	0.13	0.060R	0.005
K	10.77	0.13	0.424	0.005
M	22.86	0.13	0.900	0.005
N	3.17	0.13	0.125	0.005
O	0.13	0.02	0.005	0.001
P	4.19	0.13	0.165	0.005
Q	6.35	REF	0.250	REF

FEATURES

- SIMPLIFIED AMPLIFIER DESIGN
- SUITABLE FOR BROAD BAND APPLICATIONS
- LOW  $C_{rss}$
- SIMPLE BIAS CIRCUITS
- LOW NOISE
- HIGH GAIN – 14 dB MINIMUM

APPLICATIONS

- HF/VHF/UHF COMMUNICATIONS  
from 1 MHz to 200 MHz

ABSOLUTE MAXIMUM RATINGS ( $T_{case} = 25^{\circ}C$  unless otherwise stated)

$P_D$	Power Dissipation	220W
$BV_{DSS}$	Drain – Source Breakdown Voltage	70V
$BV_{GSS}$	Gate – Source Breakdown Voltage	$\pm 20V$
$I_{D(sat)}$	Drain Current	30A
$T_{stg}$	Storage Temperature	-65 to 150°C
$T_j$	Maximum Operating Junction Temperature	200°C

## ELECTRICAL CHARACTERISTICS (T<sub>case</sub> = 25°C unless otherwise stated)

Parameter	Test Conditions	Min.	Typ.	Max.	Unit
B <sub>V</sub> DSS Drain–Source Breakdown Voltage	V <sub>GS</sub> = 0      I <sub>D</sub> = 100mA	70			V
I <sub>D</sub> DSS Zero Gate Voltage Drain Current	V <sub>DS</sub> = 28V      V <sub>GS</sub> = 0			6	mA
I <sub>G</sub> DSS Gate Leakage Current	V <sub>GS</sub> = 20V      V <sub>DS</sub> = 0			1	μA
V <sub>GS(th)</sub> Gate Threshold Voltage*	I <sub>D</sub> = 10mA      V <sub>DS</sub> = V <sub>GS</sub>	1		7	V
g <sub>fs</sub> Forward Transconductance*	V <sub>DS</sub> = 10V      I <sub>D</sub> = 6A	4.8			S
G <sub>PS</sub> Common Source Power Gain	P <sub>O</sub> = 120W	14			dB
η Drain Efficiency	V <sub>DS</sub> = 28V      I <sub>DQ</sub> = 1.2A	50			%
VSWR Load Mismatch Tolerance	f = 175MHz	20:1			—
C <sub>iss</sub> Input Capacitance	V <sub>DS</sub> = 0V      V <sub>GS</sub> = -5V      f = 1MHz			360	pF
C <sub>oss</sub> Output Capacitance	V <sub>DS</sub> = 28V      V <sub>GS</sub> = 0      f = 1MHz			180	pF
C <sub>rss</sub> Reverse Transfer Capacitance	V <sub>DS</sub> = 28V      V <sub>GS</sub> = 0      f = 1MHz			15	pF

\* Pulse Test: Pulse Duration = 300 μs , Duty Cycle ≤ 2%

## HAZARDOUS MATERIAL WARNING

The ceramic portion of the device between leads and metal flange is beryllium oxide. Beryllium oxide dust is highly toxic and care must be taken during handling and mounting to avoid damage to this area.

**THESE DEVICES MUST NEVER BE THROWN AWAY WITH GENERAL INDUSTRIAL OR DOMESTIC WASTE.**

## THERMAL DATA

R <sub>THj-case</sub>	Thermal Resistance Junction – Case	Max. 0.8°C / W
-----------------------	------------------------------------	----------------

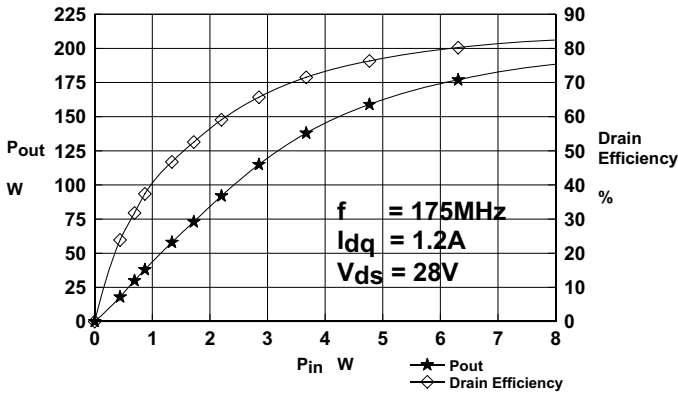

**Figure 1.**  
Power Output and Efficiency vs. Input Power

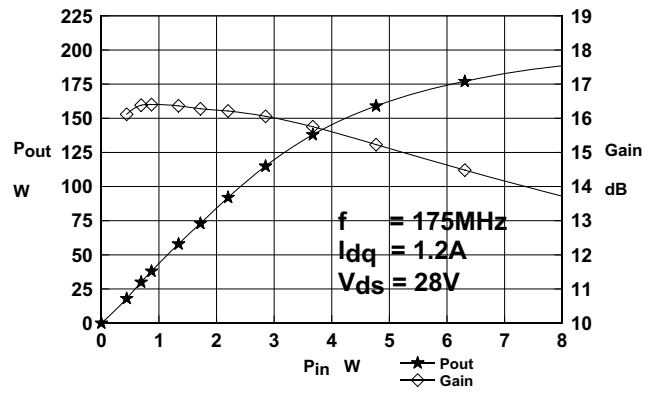

**Figure 2.**  
Power Output and Gain vs. Input Power

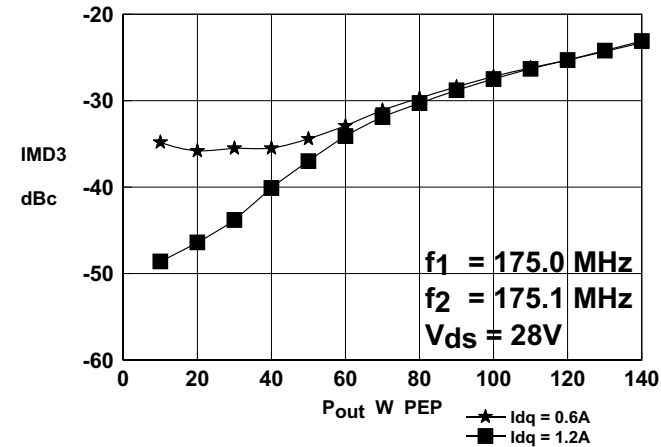

**Figure 3.**  
IMD vs Output Power

**D1006UK**  
**OPTIMUM SOURCE AND LOAD IMPEDANCE**

Frequency MHz	Z <sub>S</sub> Ω	Z <sub>L</sub> Ω
175	0.5 - j0.6	1.7 - j0.1

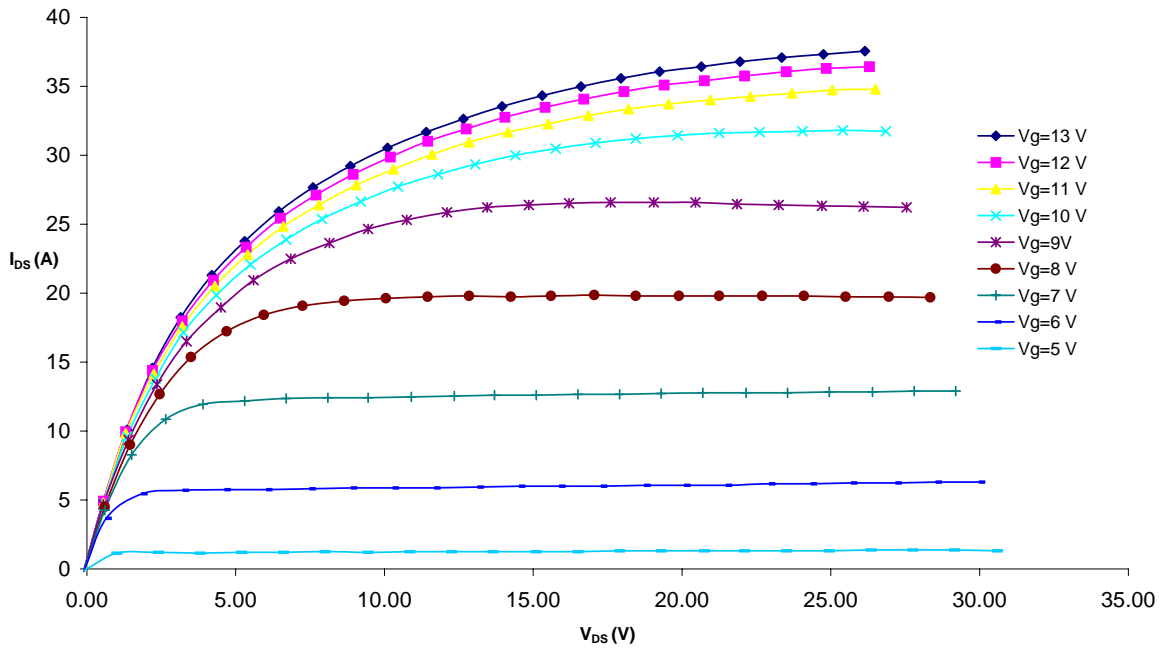

**Figure 4 – Typical IV Characteristics.**

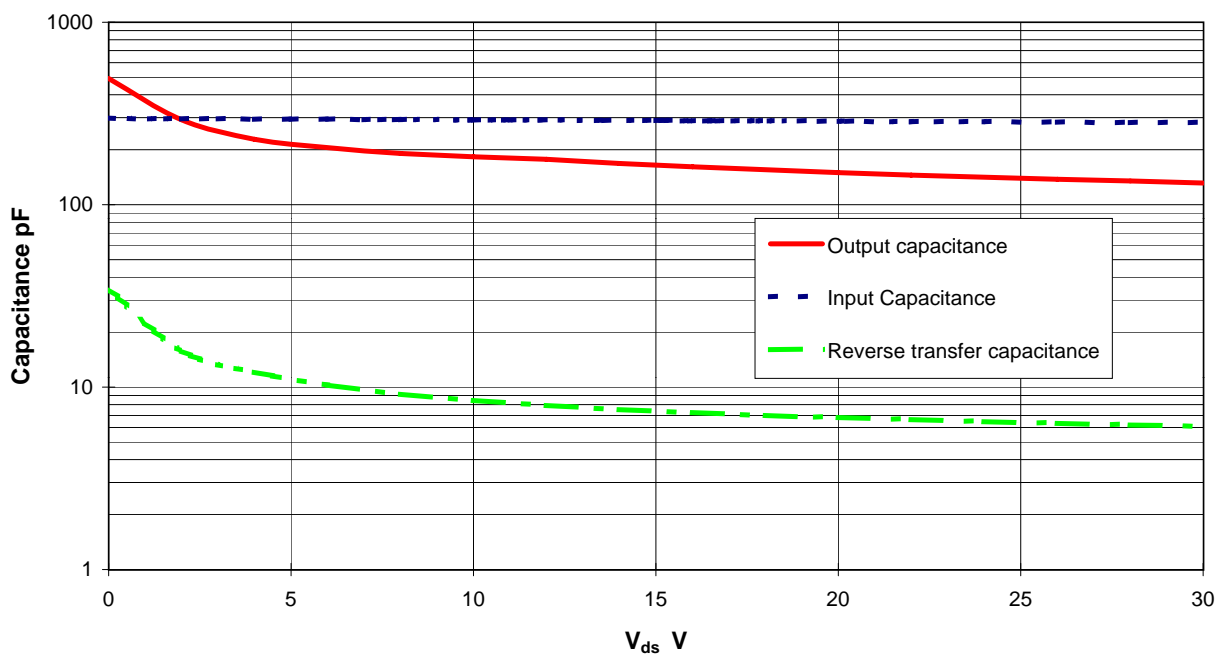

**Figure 5 – Typical CV Characteristics.**

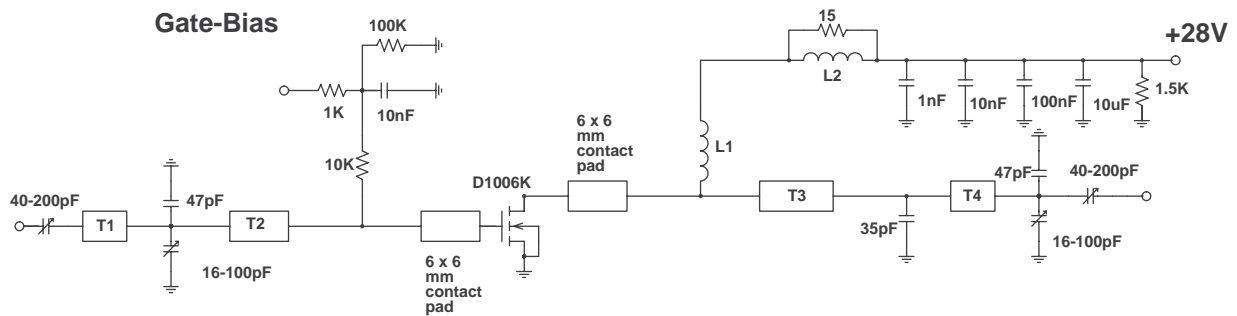

### 175 MHz Test Fixture

Substrate 1.6mm PTFE/glass,  $\epsilon_r = 2.5$

All microstrip lines  $W = 5\text{mm}$

- T1 10mm
- T2 23.5mm
- T3 25mm
- T4 6mm
- L1 9 turns 20swg enamelled copper wire, 6mm i.d.
- L2 11 turns 19swg enamelled copper wire on Fair-Rite FT82 ferrite core